

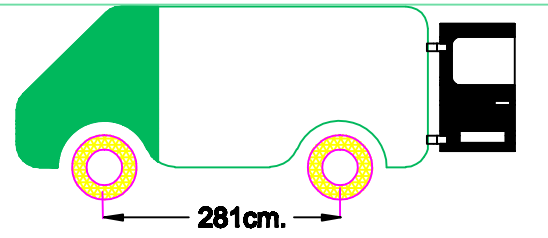

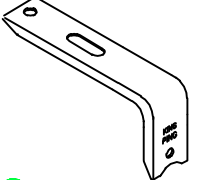

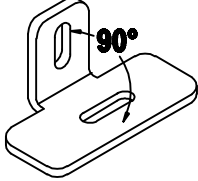

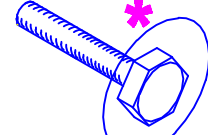

DACIA DOKKER

200x123 cm.

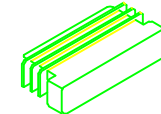
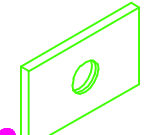

 S	4x	 90°	4x
 M8x20	12x	 M8x25	4x Max. 20Nm
 M8	16x	 4x	
 3xD M8	12x	 4x	
 M8	12x	 M8	8x
		 2x	

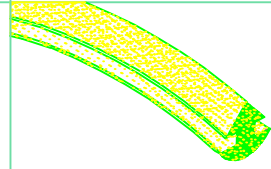
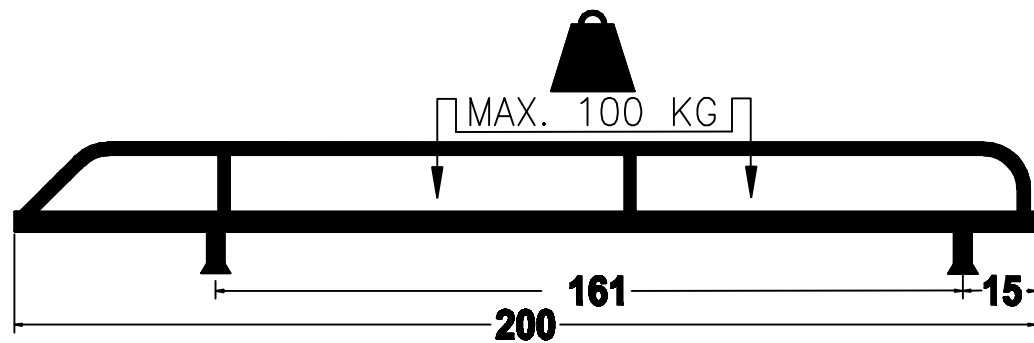

Het zwarte P.V.C. afdichtprofiel in het railprofiel DRUKKEN dit om e.v. het fluiten en/of regen-opname tegen te gaan.

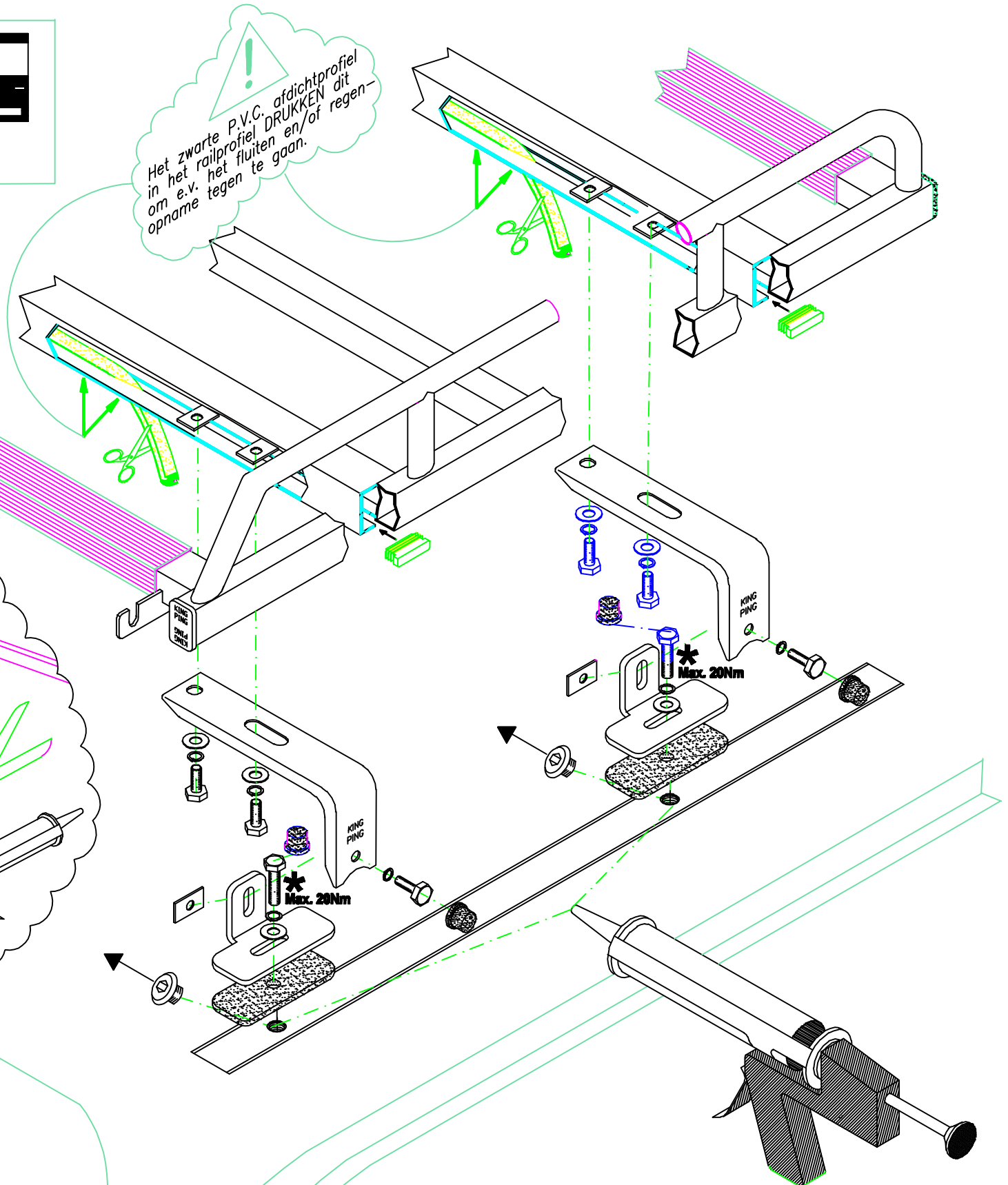
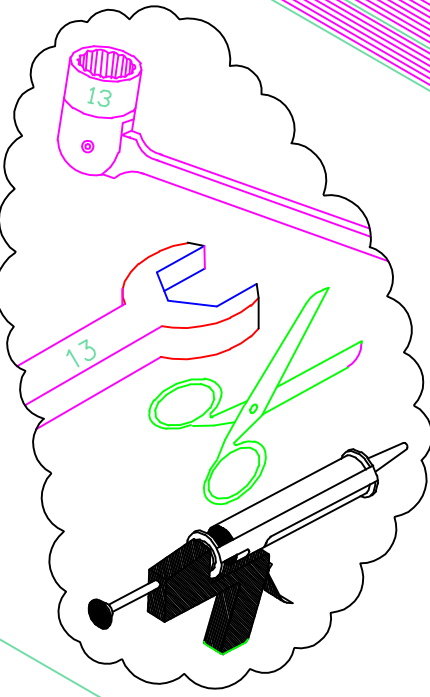

-Bij onduidelijkheden raadpleeg uw leverancier!
-Pour plus de renseignements consultez votre fournisseur!
-Bei eventuellen Unklarheiten, bitten wir Sie mit Ihren
-Lieferanten Kontakt aufzunehmen!
-Might this not be clear, please contact your supplier!